

SOPA6302S2PN



Category	60cm
Product Family	Oven
Power supply	Electric
Heat source	ELECTRICITY
Cooking method	Combi Steam
Galileo Technology	Pyro steam
Cleaning system	Pyrolitic
EAN code	8017709313982



Aesthetics

Aesthetic	Classic	Serigraphy colour	Silver
Colour	Black	Serigraphy type	Symbols
Finishing	Matt	Door	With 2 horizontal strips
Design	Flat	Handle	Classic
Material	Stainless steel	Handle Colour	All black special edition
Glass Type	Eclipse	Logo	Silk screen

Controls



Display name	EvoScreen	No. of controls	2
Display technology	LCD	Control knobs	Classic
Control setting	Knobs & touch buttons	Controls colour	Matt black

Programs / Functions

No. of cooking functions 12

Traditional cooking functions

 Static	 Fan assisted	 Circulaire
 Turbo	 Eco	 Large grill
 Base	 Pizza	

Cooking functions with steam



Fan assisted



Circulaire

Turbo

Grill + fan

Other Steam functions



Tank cleaning



Water outlet



Water input



Descaling

Other functions



Defrost by time



Proving



Stone cooking



BBQ



Air-Fry



Sabbath

Cleaning functions



Pirolysis

Options



Time-setting options Delay start and automatic end cooking

Minute minder Yes

Timer 1

Controls Lock / Child Safety Yes

Other options Keep warm, Eco light, Tones, Brightness

Cooking with probe thermometer Yes

Showroom demo option Yes

Rapid pre-heating Yes

Technical Features



Minimum Temperature 30 °C

Maximum temperature 280 °C

No. of shelves 5

Shelves type Metal racks

N. of fans 1

No. of lights 2

Light type Halogen

User-replaceable light Yes

Light Power 40 W

Light when door is opened Yes

Lower heating element power 1200 W

Removable door Yes

Full glass inner door Yes

Removable inner door Yes

Total no. of door glasses 4

Soft Close hinges Yes

Soft Open Yes

Safety Thermostat Yes

Chimney Fixed

Cooling system Tangential

Cooling duct Double

Speed Reduction Yes

Cooling System

Upper heating element - Power	1000 W	Door Lock During Pyrolysis	Yes
Grill element - power	1700 W	Steam range	20 - 40%
Large grill - Power	2700 W	Usable cavity space dimensions (HxWxD)	353x470x401 mm
Circular heating element - Power	2000 W	Temperature control	Electronic
Heating suspended when door is opened	Yes	Cavity material	Ever clean Enamel
Door opening type	Standard opening	Water loading	Drawer, manual
Door	Cool	Tank capacity	0,8 l

Performance / Energy Label



Energy efficiency class	A+	Energy consumption in forced air convection	2.45 MJ
Net volume of the cavity	68 l	Energy consumption per cycle in fan-forced convection	0.68 kWh
Energy consumption per cycle in conventional mode	1.09 kWh	Number of cavities	1
Energy consumption in conventional mode	3.92 MJ	Energy efficiency index	81 %

Accessories Included



Rack with back stop	1	Insert grid	1
Enamelled tray (20mm)	1	Telescopic Guide rails, partial Extraction	1
Enamelled deep tray (50mm)	1	Temperature probe	Yes, single point

Electrical Connection

Plug	(I) Australia	Nominal power	3000 W
Voltage	220-240 V	Frequency (Hz)	50/60 Hz
Current	13 A	Power supply cable length	115 cm

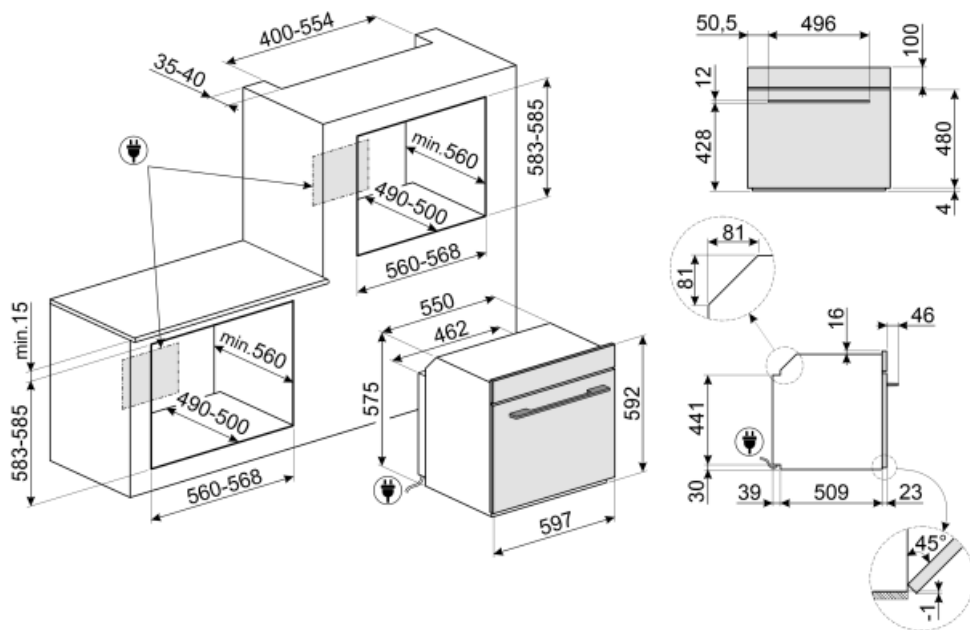

Not included accessories

AIRFRY

Air fryer rack AIRFRY . Ideal for recreating traditional frying in the oven, but with fewer calories and less fat. It allows you to cook quickly and simply dishes such as French fries, fried vegetables and fish, ensuring perfect browning and crispiness.



SFLK1

Child lock



ET50

Enamelled tray, 50mm deep



ET20

Enamelled tray, 20mm deep



STONE

Rectangular refractory stone PPR2. Ideal for cooking pizzas with the same results as a typical wood-fired oven. Can also be used for baking bread, focaccias and other recipes such as pies, flans or biscuits Dimensions:L42 x H1,8 x P37,5 cm.



GTP2

Partially extractable telescopic guides (1 level), suitable for traditional ovens. Made in stainless steel, they guarantee stability and facilitate the smooth extraction of the trays.



PR3845X

Antifingerprint stainless steel. Cover for furniture in column installation of more ovens



GTT2

Totally extractable telescopic guides (1 level), suitable for traditional ovens. Made in stainless steel, they guarantee stability and facilitate the smooth extraction of the trays.



BBQ

Double sided plate BBQ. Suitable for recreating succulent and crispy dishes in the oven with the typical taste of grilled cooking. The ribbed side is particularly suitable for meats and cheeses. The smooth side for fish, seafood and vegetables.



PALPZ

Pizza shovel with fold away handle width: 315mm length : 325mm























Alternative products

























SOPA6302S2PX

Stainless steel

Symbols glossary (TT)

	Dedicated cooking function for the double sided plate BBQ. Suitable for recreating succulent and crispy dishes in the oven with the typical taste of g		...
	Child lock: some models are fitted with a device to lock the programme/cycle so it cannot be accidentally changed.		Combination steam: ovens can be used either as a steam oven, or as a traditional oven, or alternatively the two methods can be combined.
	Air cooling system: to ensure a safe surface temperatures.		Defrost by time: with this function the time of thawing of foods are determined automatically.
	A+: Energy efficiency class A+ helps to save up to 10% energy compared to class A. Maximum performance with minimum consumption is guaranteed.		Descaling function: Is essential to remove excess deposits of limestone in the tank and allow the proper operation of the product. The need to perform this operation is signaled by the product itself.
	Quadruple glazed: Number of glazed doors.		Automatic lighting switches off: for greater energy savings, the lighting switches off automatically after one minute from the start of cooking.
	Electric		Enamel interior: The enamel interior of all Smeg ovens have a special antacid lining which helps keep the interior clean by reducing the amount of cooking grease adhering to it.
	Fresh Touch: Most of Smeg ovens have a "cool door." Thanks to the combination of tangential cooling and internal heat-reflecting glasses, the temperature on the outer surface of the door is maintained below 50° C. In addition to providing safety, this system protects the sides of the furniture from overheating by the oven.		Fan with upper and lower elements: The elements combined with the fan aim to provide more uniform heat, a similar method to conventional cooking, so pre-heat is required. Most suitable for items requiring slow cooking methods.
	Upper and lower element only: a traditional cooking method best suited for single items located in the centre of the oven. the top pf the oven will always be hottest. Ideal for roast, fruit cakes, bread etc.		Lower heating element only: This function is ideal for foods that require extra base temperature without browning, e.g. pastry dishes, pizza. Also suitable for slow cooking of stews and casseroles.
	...		Dedicated cooking function for the Air fryer rack AIRFRY . Ideal for recreating traditional frying in the oven, but with fewer calories and less fat.
	Circulaire: The combination of the fan and circular element around it gives a hot air cooking method. This provides many benefits including no preheat if cook time is more than 20 minutes, no flavour transfer when cooking different foods at the same time, less energy, and shorter cook times. Good for all types of food.		ECO: The combination of the grill, fan and lower element is particularly suitable for cooking small quantities of food.

- | | |
|---|---|
|  <p>Grill element: Using of grill gives excellent results when cooking meat of medium and small portions, especially when combined with a rotisserie (where possible). Also ideal for cooking sausages and bacon.</p> |  <p>Pizza function: The simultaneous operation of three elements ensures an optimum cooking facility when used with the Smeg pizza stone.</p> |
|  <p>Fan combined with traditional cooking, where heat is generated from above and below, provides uniform heat. Adding the steam function allows the same cooking results in less time.</p> |  <p>Circulaire element with steam: Cooking with the simultaneous use of the circular heating element in combination with fan and steam supply.</p> |
|  <p>FUN_STEAM_OTHER_WATER_IN_OUT_72dpi</p> |  <p>Circulaire with upper and lower elements: The use of the fan with both elements allows food to be cooked quickly and effectively, ideal for large joints that require thorough cooking. It offers a similar result to rotisserie, moving the heat around the food, instead of moving the food itself, enabling any size or shape to be cooked.</p> |
|  <p>All glass inner door: All glass inner door, a single flat surface which is simple to keep clean.</p> |  <p>The inner door glass: can be removed with a few quick movements for cleaning.</p> |
|  <p>KEEP_WARM_72dpi</p> |  <p>Side lights: Two opposing side lights increase visibility inside the oven.</p> |
|  <p>Pyrolytic: Pyrolytic cleaning cycles can be selected as necessary to automatically clean the oven interior.</p> |  <p>Cooking with temperature probe: It is possible to display the temperature detected by the probe and set a target temperature that the dish must reach. When the core of the dish reaches the desired temperature, cooking stops</p> |
|  <p>Air at 40°C provides the perfect environment for proving yeast type dough mixes. Simply select the function and place dough in the cavity for allotted</p> |  <p>Rapid preheat: The rapid preheat function can be used to reach the selected temperature in just a few minutes.</p> |
|  <p>Sabbath: This function allows you to cook food during the Sabbath, the Holiday of rest in the Jewish religion, respecting the precepts. The oven works</p> |  <p>The oven cavity has 5 different cooking levels.</p> |
|  <p>Soft close: all models are equipped with advanced function of smooth closing of the door, which allows the device to close smoothly and quietly.</p> |  <p>To guarantee the optimal functioning of the appliance, it is suggested to carry out the tank cleaning roughly once every 2-3 months.</p> |
|  <p>Telescopic rails: allow you to pull out the dish and check it without having to remove it from the oven entirely.</p> |  <p>Electronic control: Allows you to maintain temperature inside the oven with the precision 2-3 ° C. This enables to cook meals that are very sensitive to temperature changes, such as cakes, souffles, puddings.</p> |
|  <p>The capacity indicates the amount of usable space in the oven cavity in litres.</p> |  <p>Dedicated cooking function for the rectangular refractory stone PPR2 Dimensions Ideal for cooking pizzas with the same results as a typical wood-fire</p> |